

RS422 DE9 CONNECTOR
CHART FOR DE9 PIN-OUT

PIN NBR	RS 422 SIGNAL
1	NC
2	TX- (RX-)
3	RX+ (TX+)
4	GROUND
5	SPARE (PRIORITY)
6	GROUND
7	TX+ (RX+)
8	RX- (TX-)
9	NC

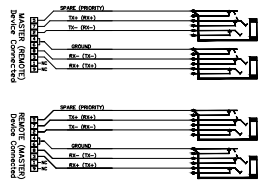

RS422 SCHEMATIC

DRAWN AS (NON-NORMALED VIEW) INTERNAL SHUNTS NOT SHOWN

ACCESSORY PART NUMBERS

- PART # DESCRIPTION
- 382811-0: WHITE PROGRAMING SHUNTS
 - 382811-9: RED PROGRAMING SHUNTS
 - DE9SLIM1: DE9 SLIM HOOD WITH THUMB SCREWS
 - DS-9P/T: DE9 MALE SOLDER CONNECTOR

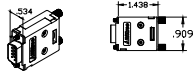

CONNECTORS AND SHELL ASSEMBLIES ARE SOLD SEPARATELY.

INTERNAL PROGRAMMING SHUNTS SHOWN AS NON-NORMALED ALL SHUNTS MUST BE REMOVED ON J6 AND J7 TO BE PROPERLY NON-NORMALED.

SHUNTS FACTORY REMOVED

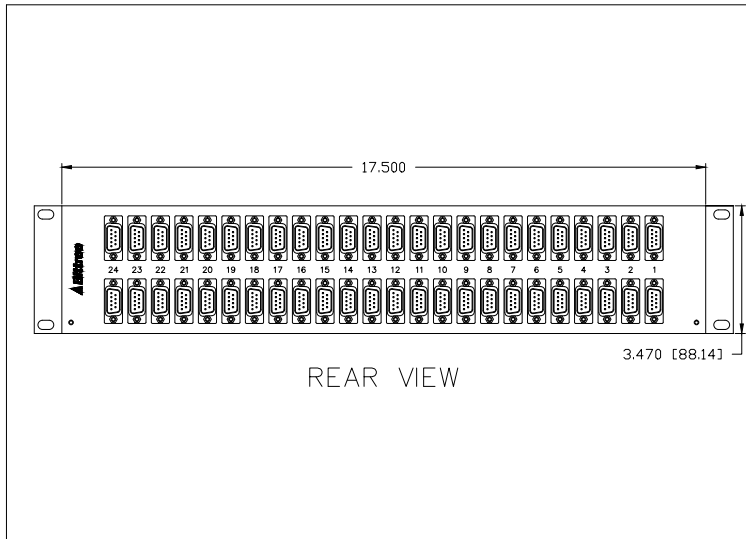
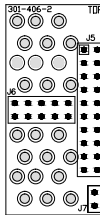

REAR VIEW

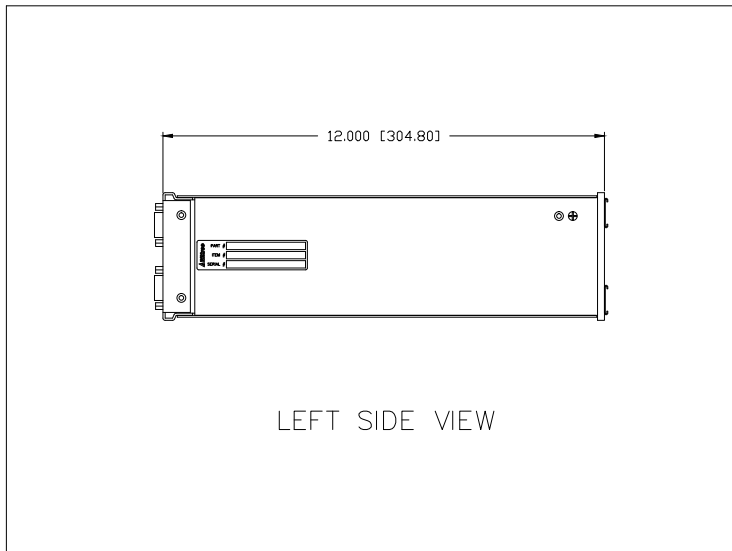

LEFT SIDE VIEW

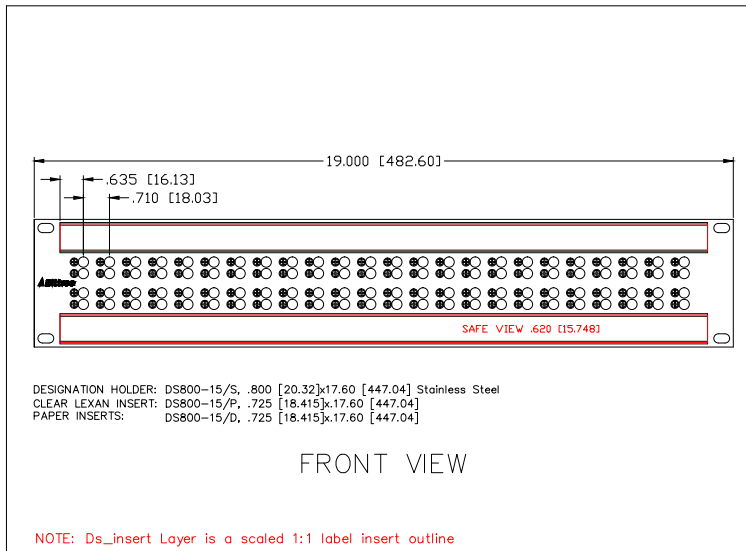

FRONT VIEW

DESIGNATION HOLDER: DS800-15/S, .800 [20.32]x17.60 [447.04] Stainless Steel
CLEAR LEXAN INSERT: DS800-15/P, .725 [18.415]x17.60 [447.04]
PAPER INSERTS: DS800-15/D, .725 [18.415]x17.60 [447.04]

NOTE: Ds_insert Layer is a scaled 1:1 label insert outline



PATCHING SYSTEMS

AUDIO, VIDEO, SERIAL DATA
600 WEST ELK AVENUE
GLENDALE, CA. 91204
TEL 818 500-8142
FAX 818 500-7062
WWW.BITTREE.COM

DATA CONTAINED IN THIS DOCUMENT IS PROPRIETARY AND SHALL NOT BE DISCLOSED, COPIED OR USED FOR PROCUREMENT OR MANUFACTURE WITHOUT EXPRESS WRITTEN PERMISSION OF BITTREE INCORPORATED

DWG. NO: B422NI6TD924RE

PART NO: B422-NI6T/24

SERIES: DATA

DWG. SCALE : FULL

PANEL HEIGHT:
2 RU (3.470") [88.138]

DESIGNATION : DS800-15

FINISH : BLACK POWDER COAT

PANEL MATERIAL:
3/16" [4.7625] ALUMINUM

JACK SCREWS: M3-0.5X12FLPH-S

LAYER (DS_INSERT) IS PROVIDED FOR THE CREATION OF LEGEND STRIPS FOR THIS PATCHBAY. THE RED OUTLINE MATCHES THE SIZE OF INSERT.

PLEASE NOTE THE VIEWABLE AREA IS LISTED IN NOTES BELOW THE FRONT PANEL VIEW.